



Owner's Manual

Cat. No. 20-520

PRO-90 300-Channel TrunkTracker Scanner

Please read before using this equipment.

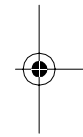
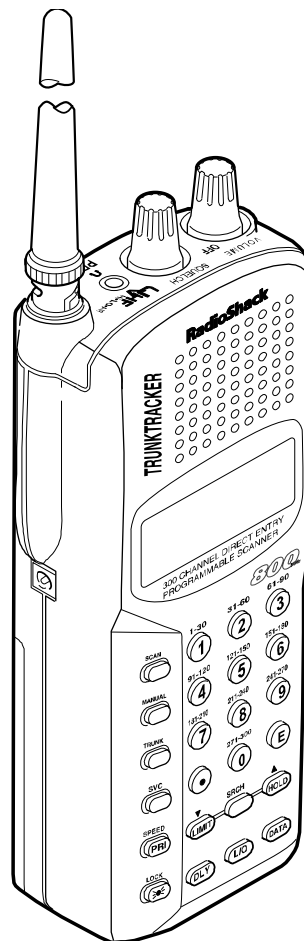
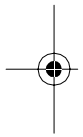

RadioShack®





FEATURES



Your new RadioShack PRO-90 300-Channel Trunk-Tracker Scanner is the first of a new generation of scanners designed to track Motorola™ Type I and Type II (such as Smartnet™, and Privacy Plus™) and hybrid analog trunking systems, which are extensively used in many 800 MHz communication systems.

Trunking communications systems let a large group of 2-way radio users (or even different groups of 2-way radio users) efficiently use a large range of frequencies. Instead of selecting a specific frequency for a transmission, the 2-way radio user simply selects a talk group. The trunking system automatically transmits the call on the first available frequency, and also sends a code that uniquely identifies that 2-way radio user's transmission on a different frequency called a data channel.

Since the trunking system might send individual 2-way radio user's calls and response transmissions on different frequencies, it is difficult to listen to trunked communications using a regular scanner. The PRO-90 lets you select and monitor the data channel frequency sent with a 2-way radio user's transmission, so you can hear the call and response for that 2-way radio user and easily "follow" the conversation.

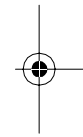
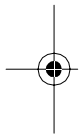

The scanner also lets you scan conventional transmissions, and is preprogrammed with service-search banks for convenience. By pressing a single button, you can quickly search those frequencies most commonly used by public service and other agencies without tedious and complicated programming.

This scanner gives you direct access to over 31,000 exciting frequencies, including police and fire departments, ambulance services, and amateur radio services, and you can change your selection at any time.

Your scanner also has these special features:

Triple-Conversion Circuitry — virtually eliminates any interference from IF (intermediate frequency) images, so you hear only the selected frequency.

© 1997 Tandy Corporation.
All Rights Reserved.

RadioShack is a registered trademark used by Tandy Corporation.
HyperSearch and HyperScan are trademarks used by
Tandy Corporation.

Motorola, Smartnet, and Privacy Plus are trademarks of
Motorola, Inc.





Ten Channel-Storage Banks — let you store 30 channels in each bank to group channels so you can more easily identify calls.

Five Scan Lists — let you store up to 50 IDs in each tracking bank (up to a total of 500).

Two-Second Scan Delay — delays scanning for about 2 seconds before moving to another channel, so you can hear more replies that are made on the same channel.

Lock-Out Function — lets you set your scanner to skip over specified channels or frequencies when scanning or searching, and skip over IDs when tracking trunked systems.

Priority Channels — lets you program one channel in each bank (10 in all) and then have the scanner check it every 2 seconds so you don't miss transmissions on those channels.

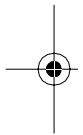

Five Service-Search Banks — lets you search preset frequencies in separate police, fire/emergency, aircraft, marine, and weather banks, to make it easy to locate specific types of calls.

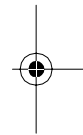

HyperSearch™ and HyperScan™ — lets you set the scanner to search at up to 300 steps per second and scan at up to 100 frequencies per second in frequency bands with 5 kHz steps, to help you quickly find interesting broadcasts. The normal search speed is 100 steps per second.

Data Signal Skip — lets you set the scanner to skip non-modulated or data signals during searches. This lets the scanner avoid non-voice signals, making a search faster.

Key Lock — lets you lock the scanner's keys to help prevent accidental changes to the scanner's programming.

Manual Access — lets you directly access any channel.

Liquid-Crystal Display — makes it easy to view and change programming information.

Display Backlight — makes the scanner easy to read in low-light situations.





Flexible Antenna with BNC Connector — provides excellent reception and is designed to help prevent antenna breakage. Or, you can connect an external antenna.

Memory Backup — keeps the frequencies stored in memory for an extended time.

Three Power Options — let you power the scanner using the built-in rechargeable battery pack, external AC power using the supplied AC adapter/charger, or DC power using an optional DC cigarette-lighter power cable.

Key Confirmation Tones — the scanner sounds a tone when you perform an operation correctly, and an error tone if you make an error.

Battery Low Alert — warns you when battery power gets low.

Battery Save — saves battery power when the scanner does not detect any transmissions for more than 1 minute when a channel is manually selected.

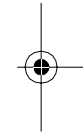
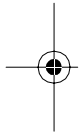

Your scanner can receive these bands:

Frequency Range	Step	Transmission
29–29.7 MHz	5 kHz	10-Meter Ham Band
29.7–50 MHz	5 kHz	VHF Lo
50–54 MHz	5 kHz	6-Meter Ham Band
108–136.9875 MHz	12.5 kHz	Aircraft
137–144 MHz	5 kHz	Military Land Mobile
144–148 MHz	5 kHz	2-Meter Ham Band
148–174 MHz	5 kHz	VHF Hi
406–420 MHz	12.5 kHz	Federal Government
420–450 MHz	12.5 kHz	70-cm Ham Band
450–470 MHz	12.5 kHz	UHF Standard Band
470–512 MHz	12.5 kHz	UHF “T” Band
806–956 MHz	12.5 kHz	Public Service “800” Band, except cellular band





We recommend you record your scanner's serial number here. The number is on the bottom panel.

Serial Number: _____

FCC NOTICE

Your scanner might cause radio or TV interference even when it is operating properly. To determine whether your scanner is causing the interference, turn off your scanner. If the interference goes away, your scanner is causing it. Try the following methods to eliminate the interference:

- Move your scanner away from the receiver
- Connect your scanner to an outlet that is on a different electrical circuit from the receiver
- Contact your local RadioShack store for help

Note: Mobile use of this scanner is unlawful or requires a permit in some areas. Check the laws in your area.

SCANNING LEGALLY

Your scanner covers frequencies used by many different groups including police and fire departments, ambulance services, government agencies, private companies, amateur radio services, military operations, pager services, and wireline (telephone and telegraph) service providers. It is legal to listen to almost every transmission your scanner can receive. However, there are some transmissions you should never intentionally listen to. These include:

- Telephone conversations (either cellular, cordless, or other private means of telephone signal transmission)
- Pager transmissions
- Any scrambled or encrypted transmissions

According to the Electronic Communications Privacy Act (ECPA), you are subject to fines and possible imprisonment for intentionally listening to, using, or divulging the contents of such a transmission unless you have the consent of a party to the conversation (unless such activity is otherwise illegal). We encourage responsible, legal scanner use.

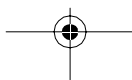
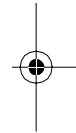
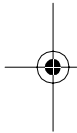



CONTENTS



Preparation	8
Power Sources	8
Using the Rechargeable Battery Pack	8
Using Standard AC Power	9
Using Vehicle Battery Power	10
Connecting the Antenna	11
Connecting an Optional Antenna	12
Connecting an Earphone/Headphones	13
Listening Safely	13
Traffic Safety	13
Connecting an Extension Speaker	14
Attaching the Belt Clip	14
Understanding Your Scanner	15
A Look at the Keypad	15
A Look at the Display	17
Understanding Banks	19
Channel Storage Banks	19
Service Banks	19
Understanding Trunking	19
Operation	20
Turning On the Scanner and Setting Squelch	20
Storing Known Frequencies into Channels	21
Limit Search	22
Scanning Service Banks	23
Scanning the Stored Channels	25
Manually Selecting a Channel	25
Deleting a Stored Frequency	25
Special Features	26
Delay	26
Turning Channel-Storage Banks On and Off	27
Locking Out Channels and Frequencies	27
Locking Out Channels	27
Locking Out Frequencies	28
Priority	28
Using the Keylock	30
Using the Display Backlight	30
Changing Search Speeds	30
Battery Save	31
Skipping Data Signals	31

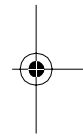
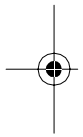



Trunk Tracking 32

- Types of Trunked Systems 32
- Setting the Scanner to the Trunk Tracking Mode 33
- Setting Squelch for the Trunk Tracking Mode 34
- Programming Trunked Frequencies 34
- Scanning a Trunked Bank 36
 - Monitoring an Active ID 37
 - Locking Out IDs 38
 - Unlocking a Single ID 38
 - Unlocking All IDs 38
 - Using Trunk Tracking Scan Delay 39
 - Monitoring IDs 39
- Channel Activity Indicators 40
- Scan Lists 41
 - Manually Storing IDs into Scan Lists 41
 - Storing IDs Into Scan Lists While Searching 42
 - Automatically Storing an ID in a Scan List Location 42
 - Deleting a Stored ID 43
- Scanning the Scan Lists 43
- Scanning Type I and Hybrid Trunked Systems ... 44
 - Selecting a Preset Fleet Map 48
 - Programming a Fleet Map 49
 - Programming a Hybrid System 50

A General Guide to Scanning 51

- Guide to Frequencies 51
 - National Weather Frequencies 51
 - Canadian Weather Frequencies 51
 - Birdie Frequencies 51
- Guide to the Action Bands 52
 - Typical Band Usage 52
 - Primary Usage 52
- Band Allocation 53
- Frequency Conversion 57

Troubleshooting 58

Care and Maintenance 61

Specifications 62

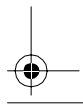
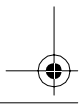
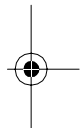
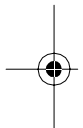



PREPARATION



POWER SOURCES

You can power your scanner from any of three sources:

- Built-in rechargeable battery pack
- Standard AC power using the supplied AC adapter/charger
- Vehicle battery power using an optional DC cigarette-lighter power cable

Using the Rechargeable Battery Pack

You must charge your scanner's built-in rechargeable battery pack before you can use it to power the scanner. Your scanner has a built-in charging circuit that lets you charge the rechargeable battery pack while it is in the scanner.

To charge the battery pack, simply connect the supplied AC adapter/charger or an optional DC cigarette-lighter power cable to the scanner's **EXT. PWR** jack. See "Using Standard AC Power" on Page 9 or "Using Vehicle Battery Power" on Page 10.

It takes about 14–16 hours to recharge a battery pack that is fully discharged. (You can operate the scanner while recharging the battery pack, but charging takes longer).

Notes:

- The scanner automatically stops charging the battery pack when it is fully charged, even if the supplied AC adapter/charger or a DC cigarette-lighter power cable is still connected to the scanner.
- A rechargeable battery pack lasts longer and delivers more power if you occasionally let it fully discharge. To do this, simply use the scanner until the low battery indicator appears. Then fully charge the battery pack.

If the battery pack doesn't power the scanner even after you charge it, you must replace it. You can order a replacement battery pack from your local RadioShack store.

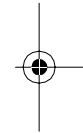
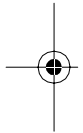

1. Press down on the battery compartment cover and slide the cover in the direction of the arrow to remove it.

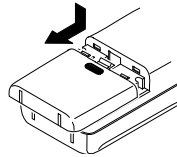

2. Disconnect the battery pack's connector from the scanner's connector. Then remove the battery pack from the battery compartment.
3. Attach the new battery pack's connector to the battery socket inside the battery compartment. Then put the battery pack into the compartment.

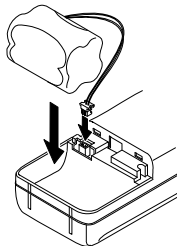

4. Replace the cover.

When the scanner's battery gets low,  blinks and the scanner beeps about every 15 seconds.

Important: At the end of a rechargeable battery pack's useful life, it must be recycled or disposed of properly. Contact your local, county, or state hazardous waste management authorities for information on recycling or disposal programs in your area. Some options that might be available are: municipal curbside collection, drop-off boxes at retailers such as your local RadioShack store, recycling collection centers, and mailback programs.

Using Standard AC Power

To power the scanner from AC power, use the supplied AC adapter/charger. Plug the adapter/charger's barrel plug into the scanner's **EXT. PWR** jack. Then plug the AC adapter/charger's power module into a standard AC outlet.

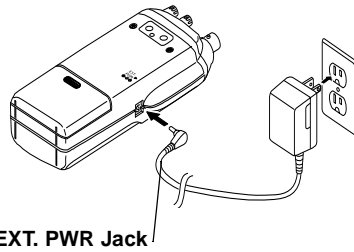

Warning: Do not use the AC adapter/charger's polarized plug with an extension cord, receptacle, or other outlet unless the blades can be fully inserted to prevent blade exposure.

Caution: Use only the supplied AC adapter/charger. It is specifically designed for this scanner.

Using Vehicle Battery Power

To power the scanner from your vehicle's cigarette-lighter socket, you need a DC cigarette-lighter power cable, such as Cat. No. 270-031.

Cautions:

- The DC cigarette-lighter power cable must be capable of delivering 12 volts, its center tip must be set to positive, and its barrel plug must correctly fit the scanner's **EXT. PWR** jack. The recommended power cable meets these specifications. Using a power cable that does not meet these specifications could damage the scanner or the power cable.
- To protect your vehicle's electrical system, always plug the power cable into the scanner before you plug it into your vehicle's cigarette-lighter socket. Always unplug the power cable from the vehicle's cigarette-lighter socket before you unplug it from the scanner.
- Insert the DC cigarette-lighter power cable's barrel plug into the **EXT. PWR** jack, then plug the power cable's other end into your vehicle's cigarette-lighter socket.

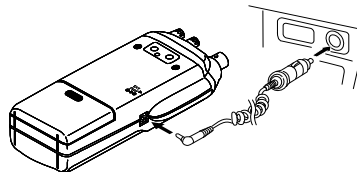

When you finish using the DC cigarette-lighter power cable, disconnect it from the cigarette-lighter socket, then disconnect it from your scanner.

Note: If the scanner does not operate properly when you connect a DC cigarette-lighter power cable, unplug the power cable from the cigarette-lighter socket and clean the socket to remove ashes and other debris.

CONNECTING THE ANTENNA

Follow these steps to attach the supplied flexible antenna to the connector on the top of your scanner.

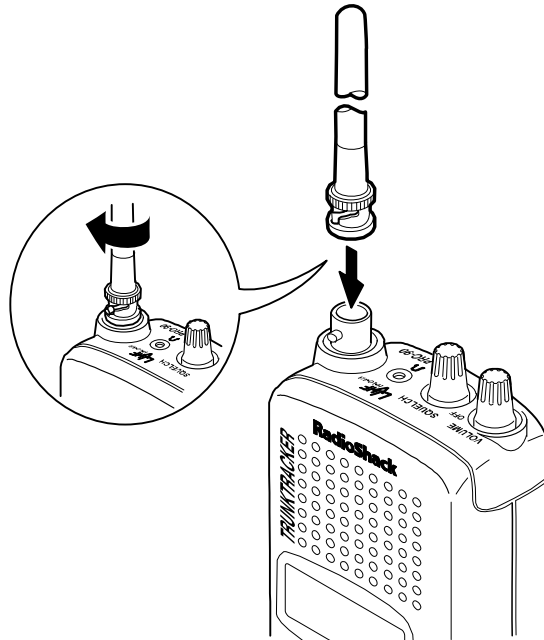

1. Align the slots around the antenna's connector with the tabs on the scanner's BNC connector.
2. Slide the antenna's connector down over the scanner's connector and rotate the antenna connector's outer ring clockwise until it locks into place.



Connecting an Optional Antenna

The scanner's antenna jack makes it easy to use the scanner with a variety of antennas. Instead of the supplied antenna, you can attach a different one, such as an external mobile antenna or outdoor base station antenna. Your local RadioShack store sells a variety of antennas.

Always use 50-ohm coaxial cable, such as RG-58 or RG-8, to connect an outdoor antenna. For lengths over 50 feet, use RG-8 low-loss dielectric coaxial cable. If your antenna's cable does not have a BNC connector, use a BNC adapter available at your local RadioShack store.

Follow the installation instructions supplied with the antenna, route the antenna cable to the scanner, then connect it to the antenna jack.

Warning: Use extreme caution when installing or removing an outdoor antenna. If the antenna starts to fall, let it go! It could contact overhead power lines. If the antenna touches a power line, contact with the antenna, mast, cable or guy wires can cause electrocution and death! Call the power company to remove the antenna. Do not attempt to do so yourself.

Cautions:

- Do not run the cable over sharp edges or moving parts.
- Do not run the cable next to power cables or other antenna cables.
- Do not run the cable through a vehicle's engine compartment or other areas that produce extreme heat.
- Follow all cautions and warnings included with the antenna.

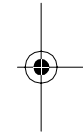
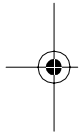

CONNECTING AN EARPHONE/ HEADPHONES

For private listening, you can plug an earphone or headphones with a 1/8-inch mini-plug (such as Cat. No. 33-175 or 20-210) into the  jack on top of your scanner. This automatically disconnects the internal speaker.

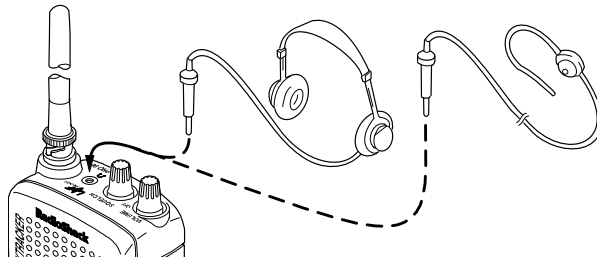

Listening Safely

To protect your hearing, follow these guidelines when you use an earphone or headphones.

- Do not listen at extremely high volume levels. Extended high-volume listening can lead to permanent hearing loss.
- Set the volume to the lowest setting before you begin listening. After you begin listening, adjust the volume to a comfortable level.
- Once you set the volume, do not increase it. Over time, your ears adapt to the volume level, so a volume level that does not cause discomfort might still damage your hearing.

Traffic Safety

Do not use an earphone/headphones with your scanner when operating a motor vehicle or riding a bicycle in or near traffic. Doing so can create a traffic hazard and could be illegal in some areas.

If you use an earphone/headphones with your scanner, be very careful. Do not listen to a continuous broadcast. Even though some earphones/headphones let you hear some outside sounds when listening at normal volume levels, they still can present a traffic hazard.

CONNECTING AN EXTENSION SPEAKER

In a noisy area, an extension speaker (such as Cat. No. 21-549), positioned in the right place, might provide more comfortable listening. Plug the speaker cable's 1/8-inch mini-plug into your scanner's  jack.

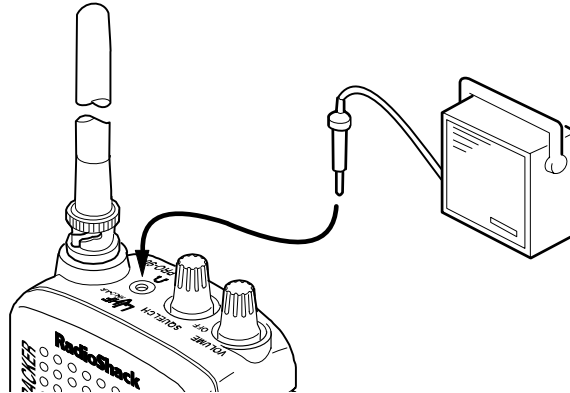

ATTACHING THE BELT CLIP

You can attach the supplied belt clip to make your scanner easier to carry when you are on the go. Use a Phillips screwdriver and the two supplied screws to attach the belt clip to the scanner. Then slide the belt clip over your belt or waistband.

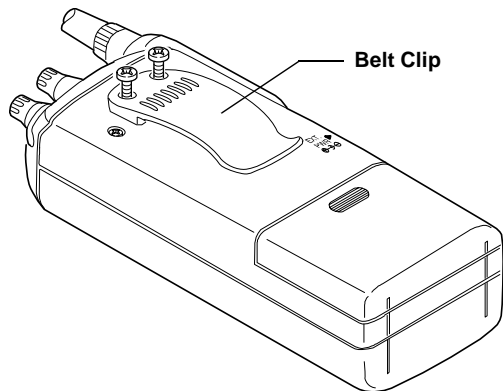

UNDERSTANDING YOUR SCANNER

Once you understand a few simple terms we use in this manual and familiarize yourself with your scanner's features, you can put the scanner to work for you. You simply find the communications you want to receive, then set the scanner to scan them.

A **frequency** is the tuning location of a station (expressed in kHz or MHz). To find active frequencies, you can use the **search** function.

You can also search the service-search banks, which are preset groups of frequencies categorized by type of service.

When you find a frequency, you can store it into a programmable memory location called a **channel**, which is grouped with your other channels in a **channel-storage bank**. You can then **scan** the channel-storage banks to see if there is activity on the frequencies stored there. Each time the scanner finds an active frequency, it stays on that channel until the transmission ends.

A LOOK AT THE KEYPAD

Your scanner's keys might seem confusing at first, but this information should help you understand each key's function.

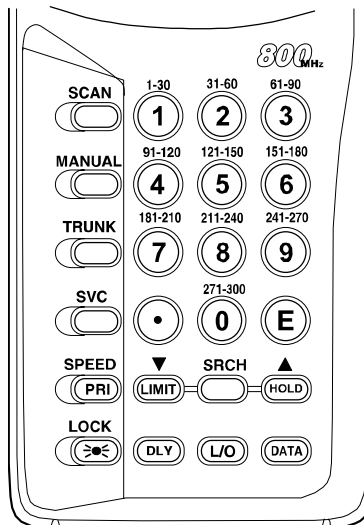



SCAN — scans through the stored channels.

MANUAL — stops scanning and lets you directly enter a channel number or frequency.

TRUNK — switches between conventional and trunk tracking modes.

SVC (service) — selects a service bank.

SPEED/PRI (speed/priority) — turns on and off the Hyper-search mode; sets and turns on and off the priority feature.

LOCK/☞☛ — locks the keypad to prevent accidental program changes. Also turns on the display light for 15 seconds.

Number Keys — each key has a single-digit label and a range of numbers. The single digits are used to enter a channel, frequency, or ID number. The range of numbers (31–60, for example) indicates the channels that make up a memory bank.

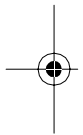

● — enters a decimal point or clears an incorrect entry.

E (enter) — enters frequencies into channels.

t/LIMIT — sets the search direction and holds the frequency search; sets the frequency range.

DLY (delay) — programs a 2-second delay for the selected channel, a limit search, or each service scan. Also programs a 5-second delay in the trunk tracking mode.

SRCH — searches a specified frequency range to find frequencies; searches for another active ID in the trunk tracking mode.

L/O (lock out) — lets you lock out selected channels or frequencies; lets you lock out a selected ID in the trunk tracking mode.

S/HOLD — sets the search direction and holds the frequency search; holds on the current ID in the trunk tracking mode.

DATA — turns on or off the data signal skip feature or checks the current trunking bank in the trunk tracking mode.



A LOOK AT THE DISPLAY

The display has indicators that show the scanner's current operating status. A good look at the display will help you understand how your scanner operates.

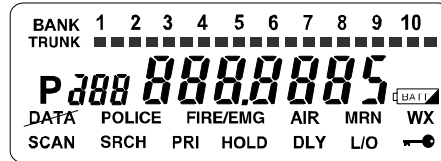

BANK — appears with numbers (1–10). Numbers with a bar under them show which channel-storage banks are turned on for scanning.

TRUNK — appears when the scanner is in the trunk tracking mode.

■ (channel activity indicators) — each represents a received trunking frequency or a data frequency in the trunk tracking mode (see “Channel Activity Indicators” on Page 40).

P — appears when a priority channel is selected.

BATT — blinks when the scanner's battery is low.

DATA — appears when the data skip function is active.

POLICE — appears when you search the police service bank.

FIRE/EMG — appears when you search the fire/emergency service bank.

AIR — appears when you search the air service bank.

MRN — appears when you search the marine service bank.

WX — appears when you search the weather service bank.

SCAN — appears when you scan channels.



SRCH — lights steadily during a limit search and ID search, and blinks while HyperSearch is active and when you monitor IDs (see “Monitoring IDs” on Page 39).

PRI — appears when the priority feature is turned on.

HOLD — appears when you manually select a channel or when the scanner is in the hold mode during a search or service bank scan or during a limit search.

DLY — appears when you program a delay.

L/O — appears when you manually select a channel or frequency you locked out.

 — appears when you lock the keypad.

Error — appears when you make an entry error.

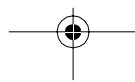
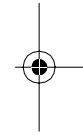
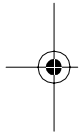



UNDERSTANDING BANKS

Channel Storage Banks

To make it easier to identify and select the channels you want to listen to, channels are divided into 10 banks of 30 channels each. Use each channel-storage bank to group frequencies, such as the police department, fire department, ambulance services, or aircraft (see "Guide to the Action Bands" on Page 52). For example, the police department might use four frequencies, one for each side of town. You could program the police frequencies starting with Channel 1 (the first channel in bank 1) and program the fire department frequencies starting with Channel 31 (the first channel in bank 2).

Service Banks

The scanner is preprogrammed with the frequencies allocated by police, fire/emergency, aircraft, marine, and weather services. This is handy for quickly finding active frequencies instead of searching through an entire band (see "Scanning Service Banks" on Page 23).

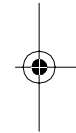
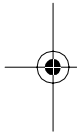

UNDERSTANDING TRUNKING

In the past, groups that broadcast frequently, such as police departments, were restricted to transmitting on just a few frequencies. This resulted in heavy traffic and often required 2-way radio users to wait for a specific frequency to clear before transmitting.

Trunked systems allow more groups of 2-way radio users to use fewer frequencies. Instead of selecting a specific frequency to transmit on, a trunked system chooses one of several frequencies when the 2-way radio user presses PTT (push to talk). The system automatically transmits the call on that frequency, and also sends a code that identifies that 2-way radio user's transmission on a data channel.

This scanner lets you select the data channel frequency that you want it to monitor, so you can hear both the call and response transmissions for that 2-way radio user and therefore follow the conversation. (You cannot listen to the data channel itself).

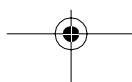

OPERATION

TURNING ON THE SCANNER AND SETTING SQUELCH

Note: Make sure the scanner's antenna is connected before you turn it on.

1. Turn **SQUELCH** fully clockwise.

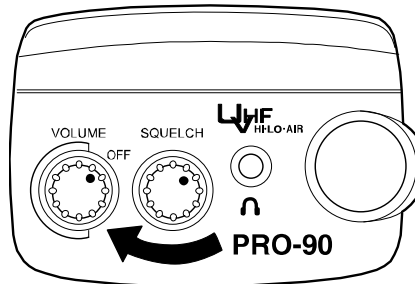

2. Turn **VOLUME/OFF** clockwise until it clicks and you hear a hissing sound.

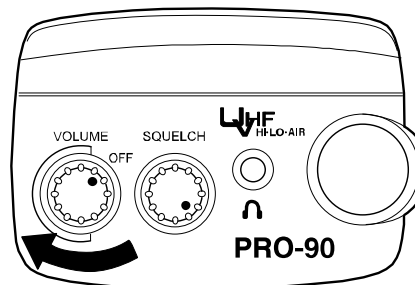

3. Press **MANUAL** and turn **SQUELCH** counterclockwise, then leave it set to a point just after the hissing sound stops.

Notes:

- If you have not stored frequencies into any channels, the scanner does not scan.
- If the scanner picks up unwanted, partial, or very weak transmissions, turn **SQUELCH** counterclockwise to decrease the scanner's sensitivity to these signals. If you want to listen to a weak or distant station, turn **SQUELCH** clockwise.
- If **SQUELCH** is adjusted so you always hear a hissing sound, the scanner does not scan properly.

STORING KNOWN FREQUENCIES INTO CHANNELS

Good references for active frequencies are the RadioShack "Police Call Guide including Fire and Emergency Services," "Official Aeronautical Frequency Directory," and "Maritime Frequency Directory." We update these directories every year, so be sure to get a current copy.

Note: To store trunking system frequencies, see "Programming Trunked Frequencies" on Page 34.

Follow these steps to store frequencies into channels.

1. Press **MANUAL**, enter the channel number where you want to store a frequency, then press **MANUAL** again. The channel number appears.
2. Use the number keys and **•** to enter the frequency (including the decimal point) you want to store.

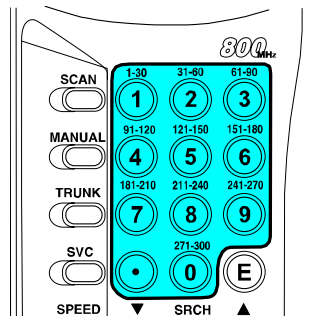

3. Press **E** to store the frequency into the channel.

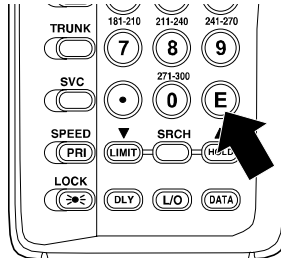

Notes:

- If you made a mistake in Step 2, **Error** appears and the scanner beeps when you press **E**. Simply start again from Step 2.
 - Your scanner automatically rounds the entered frequency to the nearest valid frequency. For example, if you enter a frequency of 151.473, your scanner accepts it as 151.475.
 - Press **DELAY** if you want the scanner to pause 2 seconds on this channel after a transmission ends before it proceeds to the next channel (see “Delay” on Page 26). The scanner also stores this setting in the channel.
4. If you want to program the next channel in sequence, press **MANUAL** and repeat Steps 2 and 3.

LIMIT SEARCH

If you do not know a frequency to store, you can search for transmissions within a range of frequencies you select, called the *limit search range*. Then you can store any interesting frequencies you find into channels.

1. Press **MANUAL**, enter the channel number where you want to store a frequency, then press **MANUAL** again. The channel number appears.
2. Use the number keys and • to enter the frequency that is the lower limit of the range you want to search.
3. Press **LIMIT**.

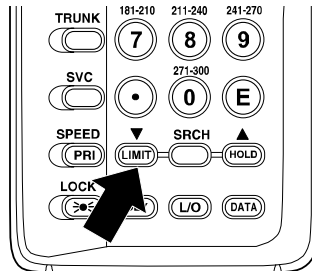

4. Use the number keys and ● to enter the frequency that is the upper limit of the range you want to search.
5. Press **LIMIT**, then press **SRCH**. The scanner begins to search from the lower limit to the upper limit.
6. When the scanner stops on a transmission, quickly press either:
 - **E** to store the displayed frequency into the channel. The scanner stores the frequency and continues searching.
 - **s** or **t** to stop searching so you can listen to the transmission. **HOLD** appears.

To release hold and continue searching, press **SRCH**.

Notes:

- To step through the frequencies while **HOLD** appears, press **s** or **t**.
- If you tune to a search skip frequency, **L/O** appears. See "Locking Out Channels and Frequencies" on Page 27.
- To skip data signals (such as modem signals), press **DATA**. See "Skipping Data Signals" on Page 31.

SCANNING SERVICE BANKS

You can scan for police, fire/emergency, aircraft, marine, and weather transmissions even if you do not know the specific frequencies that are used in your area. And, you can store any of the frequencies you find into channels.



Your scanner has the following preprogrammed service banks.

- POLICE — contains 1,079 police frequencies.
- FIRE/EMG — contains 280 fire and emergency service frequencies.
- AIR — contains 2,319 aircraft and air service frequencies.
- MRN contains 65 marine frequencies.
- WX — contains 7 weather frequencies.

To select a service bank, press **SVC**. A service bank's name (**POLICE**, **FIRE/EMG**, **AIR**, **MRN**, or **WX**) and one of the preset police frequencies appear. After a 2-second delay, scanning begins. To select another service bank, repeatedly press **SVC** until the scanner displays the name of the bank you want to use.

Notes:

- In the marine band, the active frequency and its marine channel number alternately appear.
- To skip data signals (such as modem signals), press **DATA**. See "Skipping Data Signals" on Page 31.
- Because frequencies are not always assigned to the same services everywhere, you might hear transmissions from one service in another service group.

If necessary, press **SCAN** to start scanning immediately or to continue scanning if you want to skip a frequency.

During service-scan, you can press **HOLD** to pause the scanning. **HOLD** appears. Press **s** or **t** to move up or down one step, or press **SCAN** to resume scanning.

Follow these steps to store frequencies into channels.

1. Press **MANUAL**. **HOLD** appears.
2. Use the number keys to enter the channel number (1–300) where you want to store the frequency, then press **MANUAL**.
3. Press **SVC** to select a service bank and begin scanning.
4. When the scanner stops on a transmission, press **HOLD**. The frequency appears.
5. Press **E** to store the frequency into the channel.





SCANNING THE STORED CHANNELS

To begin scanning channels, press **SCAN**. The scanner scans through all non-locked channels in the activated banks. When the scanner finds a transmission, it stops on it. When the transmission ends, the scanner resumes scanning.

Note: To scan in the trunk tracking mode, see “Scanning a Trunked Bank” on Page 36.

MANUALLY SELECTING A CHANNEL

You can continuously monitor a single channel without scanning. This is useful if you hear an emergency broadcast on a channel and do not want to miss any details — even though there might be periods of silence — or if you want to monitor a specific channel.

Follow these steps to manually select a channel.

1. Press **MANUAL**.
2. Enter the channel number.
3. Press **MANUAL** again.

Or, if your scanner is scanning and stops at the desired channel, press **MANUAL** one time. (Pressing **MANUAL** additional times causes your scanner to step through the channels.)

To resume scanning, press **SCAN**.

DELETING A STORED FREQUENCY

1. Press **MANUAL**.
2. Use the number keys to enter the channel number containing the frequency you want to delete. Then press **MANUAL** again.
3. Press **0**, then press **E**. The frequency is deleted.

Note: Channels with no frequencies are automatically locked out during scanning.

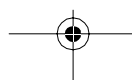

SPECIAL FEATURES

DELAY

Many agencies use a two-way radio system that might have a period of 2 or more seconds between a query and a reply. To keep from missing a reply, you can program a 2-second delay into any channel or frequency. The scanner continues to monitor the frequency for 2 seconds after the transmission stops before resuming scanning or searching.

To program a 2-second delay:

- If the scanner is scanning channel-storage banks and stops on an active channel where you want to store a delay, quickly press **DLY** before it continues scanning again. **DLY** appears.

- If the desired channel is not selected, manually select the channel, then press **DLY**. **DLY** appears.

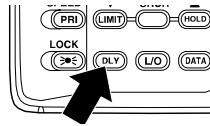

- If the scanner is scanning service banks, press **DLY** while the scanner is scanning. **DLY** appears and the scanner automatically adds a 2-second delay to every transmission it stops on in that band.

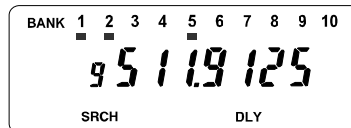

To turn off the 2-second delay, press **DLY** while the scanner is monitoring the channel or scanning the service banks. **DLY** disappears from the display.

TURNING CHANNEL-STORAGE BANKS ON AND OFF

You can turn each channel-storage bank on and off. When you turn off a bank, the scanner does not scan any of the 30 channels in that bank.

While scanning, press the number key that corresponds to the bank you want to turn on or off. If the bar under the bank number is on, the bank is turned on and the scanner scans all channels within that bank that are not locked out. If the bar is off, the scanner does not scan any of the channels within that bank.

Notes:

- You can manually select any channel within a bank, even if that bank is turned off.
- You cannot turn off all banks. One bank is always active.

LOCKING OUT CHANNELS AND FREQUENCIES

You can scan existing channels or search frequencies faster by locking out channels or frequencies that have a continuous transmission, such as a weather channel.

Note: If you just want to skip over a lengthy transmission (such as a modem signal), see "Skipping Data Signals" on Page 31.

Locking Out Channels

To lock out a channel while scanning, press **L/O** when the scanner stops on the channel. To lock out a channel manually, manually select the channel and hold down **L/O** until **L/O** appears.

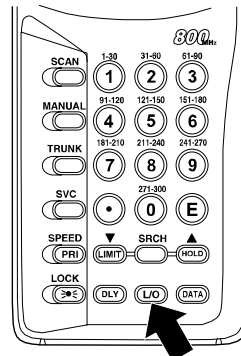
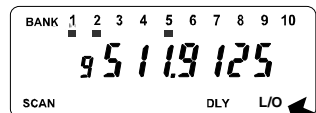



Note: You can still manually select locked-out channels.

To remove the lockout from a channel, manually select the channel and hold down **L/O** until **L/O** disappears from the display.

To unlock all channels in the banks that are turned on, press **MANUAL** to stop scanning, then hold down **L/O** until the scanner beeps twice.

Locking Out Frequencies

To lock out a frequency during a limit search or service bank scan, press **L/O** when the scanner stops on the frequency. The scanner locks out the frequency, then continues searching. To lock out a frequency manually, manually select the frequency and hold down **L/O** until **L/O** appears.

Notes:

- The scanner does not display locked-out frequencies during a search.
- You can lock out as many as 20 frequencies during a search. If you try to lock out more than 20 frequencies, the first locked-out frequency is automatically unlocked.

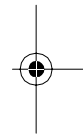
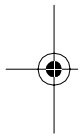

Follow these steps to remove the lockout from a frequency.

1. During a search, select the frequency you want to remove the lockout from.
2. Press **L/O**. **L/O** disappears from the display.

To remove the lockout from all frequencies, while searching, hold down **L/O** until the scanner beeps twice (about 2 seconds).

PRIORITY

The priority feature lets you scan through channels and still not miss important or interesting calls on specific channels. You can program one stored channel in each bank as a priority channel (for up to a total of 10 stored channels). As the scanner scans the bank, if the priority feature is turned on, the scanner checks the priority channels for activity every 2 seconds.



The scanner automatically designates each bank's first channel as its priority channel. Follow these steps to select a different channel as the priority channel for a bank.

1. Press **MANUAL**.
2. Enter the channel number you want to select as the priority channel, then press **MANUAL** again.
3. Hold down **PRI** until the scanner beeps twice. **P** appears to the left of the channel number.

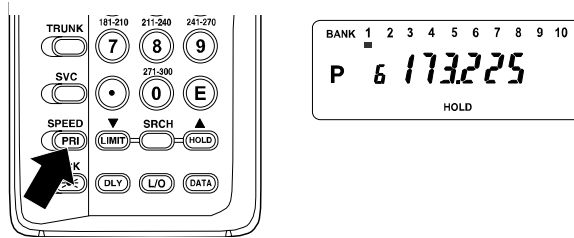

4. Repeat Steps 2–3 for the channel in each bank you want to program as a priority channel.

To turn on the priority feature, press **PRI** during scanning. **PRI** appears. Every 2 seconds the scanner checks the priority channel in each bank that is turned on, starting from the lowest to the highest-numbered priority channel.

To turn off the priority feature, press **PRI**. **PRI** disappears.

Notes:



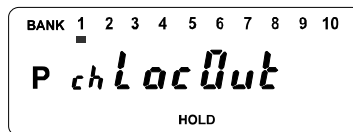

- The priority feature must be turned off to use the data skip feature (see "Skipping Data Signals" on Page 31).
- You can lock out priority channels. If you lock out all priority channels, **P ch Loc Out** appears when you turn on the priority feature.



USING THE KEYLOCK

Once you program your scanner, you can protect it from accidental program changes by turning on the keylock feature. When locked, the only controls that operate are **SCAN**, **MANUAL**, **LOCK/**, **VOLUME/OFF**, and **SQUELCH**.

Note: The keylock does not prevent the scanner from scanning channels.

To turn on the keylock, hold down **LOCK/** until  appears. To turn it off, hold down **LOCK/** until  disappears.

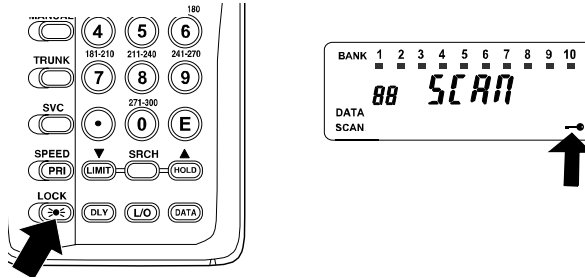

USING THE DISPLAY BACKLIGHT

You can turn on the display backlight for easy viewing at night. Press **LOCK/** to turn on the display backlight for 15 seconds. To turn off the backlight before 15 seconds elapse, press the button again.

CHANGING SEARCH SPEEDS

The PRO-90 has two search speeds for a limit search.

Normal Search	HyperSearch
100 steps/second	300 steps/second

To switch between normal and HyperSearch speeds, during a limit search, press **SPEED/PRI**. **SRCH** flashes during hypersearch.

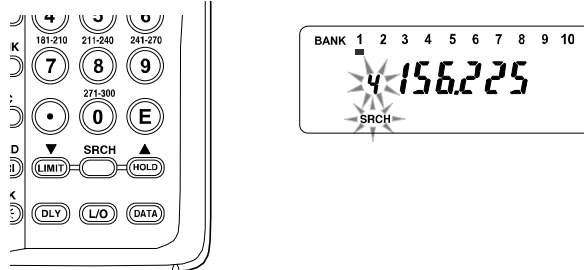

Note: You can use HyperSearch only in the 5 kHz step bands (29–54 MHz and 137–174 MHz).

BATTERY SAVE

To save battery power when a channel is manually selected, the scanner's battery save function automatically sets the scanner to a standby mode if the scanner does not receive any signals for more than 1 minute. During the standby mode, the scanner repeatedly turns off the internal power for 1 second then turns on the internal power for about $\frac{1}{3}$ of a second to check for a transmission.

Note: The scanner's battery save function does not work if the priority function is on, even if a channel is manually selected.

SKIPPING DATA SIGNALS

You can set the scanner so it skips nonmodulated or data signals (such as modem transmissions) during a search.

Note: Since data signals are not generally found in the air band, this feature does not work in the air band.

To turn on the data skip feature, be sure the priority feature is turned off (see "Priority" on Page 28), then press **DATA**. **DATA** appears. To turn off the feature, press **DATA** again. **DATA** disappears.



TRUNK TRACKING



Your scanner is designed to track transmissions on Motorola Type I, Type II, and hybrid analog trunking systems, which are extensively used in 800 MHz communications. Remember these important points when tracking transmissions:

- Your scanner monitors Type II systems by default. However, you can change this if the system in your area is different (see “Types of Trunking Systems” below and “Scanning Type I and Hybrid Trunked Systems” on Page 44 for more information).
- Your scanner cannot track transmissions on non-Motorola trunking systems.
- Your scanner cannot track an 800 MHz trunked system and scan frequencies in conventional mode at the same time.
- The frequencies for many of the 800 MHz public safety systems are listed in the separate “National Public Safety Trunked System Frequency Guide” included with your PRO-90.

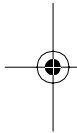

TYPES OF TRUNKING SYSTEMS

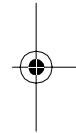

Your trunk tracking scanner can monitor two basic types of systems — *Type I* and *Type II*. Instead of selecting a specific frequency to transmit on, a trunked system chooses one of several frequencies in a 2-way radio user’s talk group when that user presses PTT (push to talk). Thus, trunking systems allocate a few frequencies among many different users, but the way Type I and Type II systems do this is slightly different. One important distinction between these systems is the amount of data transmitted by each radio when its push-to-talk button (PTT) is pressed. In a Type I system, the radio’s ID and its current affiliation (the trunk system it belongs to) are both transmitted. In a Type II system, only the radio’s ID is transmitted.

Why the difference? In Type I systems, each radio in the trunk group individually transmits its own affiliation, while the trunk system maintains a database that determines each radio’s affiliation(s) in Type II systems.

Another difference between the systems is that Type I systems are arranged in a fleet-subfleet hierarchy. For example, it is possible for a city using a Type I system to designate 4 fleets, each with 8 subfleets.





The fleets might be the police department, the fire department, utilities, and city administration. The police might decide to further divide its fleet into subfleets such as dispatch, tactical operations, detectives, north, south, east and west side patrols, and supervisors. All the available police radios would then be assigned to one of the police subfleets, letting the police centralize their communications and control the type of users on a single system. Determining the exact fleet-subfleet hierarchy for a particular area is referred to as fleet map programming.

The disadvantage of a Type I system is that the brief burst of data sent when a user transmits must contain the radio's ID and its fleet and subfleet. This is three times the amount of data a Type II system radio sends. Since the data capacity of Type I systems is limited and the amount of data increases with each user, Type I systems usually accommodate fewer users than Type II systems. Nevertheless, Type I systems are still in use.

There are also *hybrid* systems which are a combination of both Type I and Type II. Your scanner defaults to monitor Type II systems, but you can change to Type I or a hybrid of Type I and Type II systems by selecting a preprogrammed fleet map or creating a custom fleet map for your area (see "Scanning Type I and Hybrid Trunked Systems" on Page 44).

You do not need to determine the fleet-subfleet hierarchy for Type II systems unless you are tracking hybrid systems that contain both Type I and Type II systems.

SETTING THE SCANNER TO THE TRUNK TRACKING MODE

Repeatedly press **TRUNK** to switch between the scanner's conventional and trunk tracking modes.

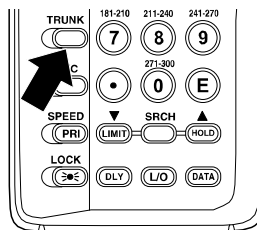

SETTING SQUELCH FOR THE TRUNK TRACKING MODE

Your scanner's squelch setting is automatically adjusted in the trunking mode, which means it is not necessary to manually adjust squelch while tracking trunked transmissions. However, the squelch setting can affect how fast your scanner acquires the data channel, and, in some instances, can prevent your scanner from acquiring the data channel at all.

We recommend you set **SQUELCH** to this position before selecting a trunked bank.

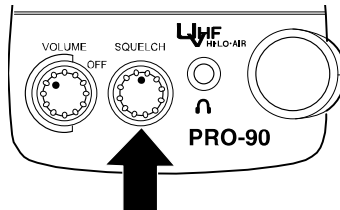

Note: You can change this setting, if necessary, to provide better performance in your area.

PROGRAMMING TRUNKED FREQUENCIES

Before you program your scanner to track a trunked system, consider the following:

- Valid trunked system frequencies range from 851.0125–868.9875 in 12.5 kHz steps.
- You can use any of your scanner's banks as either a trunk tracking bank or conventional scanning bank, but you cannot mix the two.
- The scanner only scans one trunked system at a time. Although you can store frequencies for more than one trunked system in one of your scanner's banks, the scanner only scans the frequencies associated with the first data channel it finds.

Before scanning a trunked system's transmissions, you must store the trunked system's frequencies in one of the banks in your scanner by following these steps.

1. Hold down **TRUNK** until the scanner beeps twice. **BANK**, **TRUNK**, and the bank numbers flash.

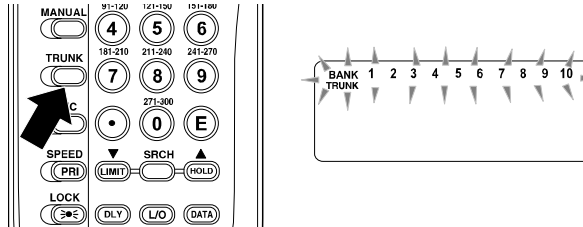

2. Select the bank you want to store the trunked system's frequencies in by pressing a number key. The scanner automatically selects the first channel in the bank when you select the bank.
3. Use the number keys to enter the trunked system's frequencies, then press **E**.

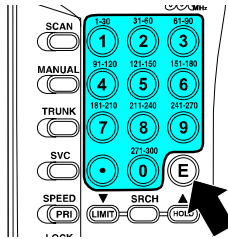

Note: If you entered an invalid frequency in Step 3, the scanner beeps, the channel number flashes and **Error** appears. If this happens, press **•** to clear the frequency, then repeat Step 3.

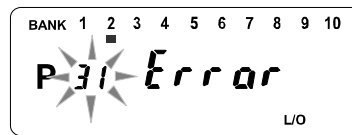

4. Press either **MANUAL** or **S** to select the next channel in the bank.

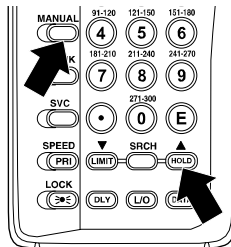

5. Repeat Steps 3 and 4 until all frequencies have been entered.

6. Press **SRCH** to begin searching for the trunk's data channel (the channel that controls the trunk). **SRCH** flashes as the scanner searches for the data channel.

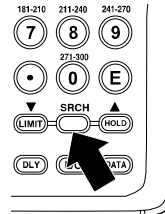

While the scanner looks through the frequencies, you see them on the display. When the scanner finds the data channel, it begins trunk tracking.

SCANNING A TRUNKED BANK

You can scan one trunked bank at a time. Once you have stored frequencies for a trunked system in one or more of the 10 available banks and you are scanning non-trunked frequencies, follow these steps to begin trunk scanning.

1. Press **TRUNK**. The indicators for all banks flash.

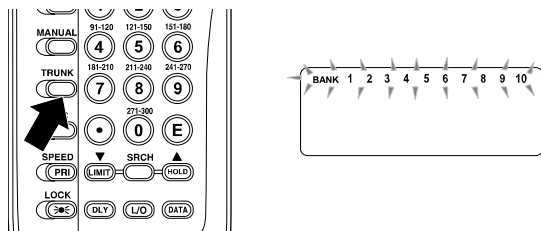

2. Use the number keys to enter the number for the trunked bank you want to scan, then press **SRCH**. The scanner searches for a data channel. When the scanner finds it, it begins trunk tracking.

If you entered all of the trunk's frequencies, you should be able to follow conversations between broadcasters even when they change frequencies. IDs, which represent different service groups, appear.

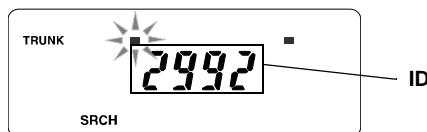

Note: To review the bank currently in use, press **DATA** while in the trunk tracking mode. The bar for the selected bank flashes at the top of the display for about 5 seconds.

3. To return to non-trunked scanning, press **TRUNK** again.

Hint: While scanning, you will not know exactly who the ID's are assigned to until you listen awhile or until you locate ID lists in frequency guides or on internet sites such as *www.trunkscanner.com*. Within a few minutes, you can usually figure out if what you are listening to is a police, fire, or emergency medical 2-way radio user. Other IDs might take some time, but determining who each ID represents is half the fun of trunk tracking!

Monitoring an Active ID

When the scanner stops on a transmission, you can hold the scanner on that transmission.

1. Press **HOLD**. **HOLD** appears, the scanner stays on the current ID, and the channel number changes.

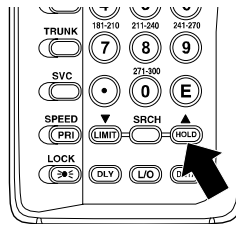

2. If you want to listen to a different ID, use the number keys to enter the ID you want to hold.
3. Press **HOLD** again. **HOLD** flashes and the scanner monitors that ID.
4. When you want to stop the hold and resume searching for a data channel so you can continue trunk tracking, press **SRCH**.

Note: You can also follow these steps to hold on an ID while scanning a scan list. See "Scan Lists" on Page 41.

Locking Out IDs

As with conventional scanning, it is possible to lock out unwanted traffic. This is particularly important in trunked systems because signals you cannot listen to (such as water meters, door alarms, traffic signals, and encrypted signals) are assigned IDs just like other users. You can have up to 100 IDs locked out at one time.

Note: If you lock out an ID while searching, it is also locked out of the scan list(s). See "Scan Lists" on Page 41.

To lock out an ID, press **L/O** when the ID appears.

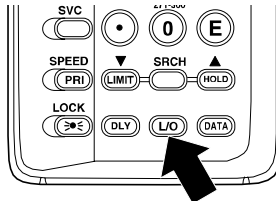

The ID is locked out, and the next active ID appears.

Unlocking a Single ID

1. Hold down **L/O** until you hear two short beeps.
2. Repeatedly press **t** or **s** to select the ID you want to unlock.
3. Press **L/O**.
The ID is unlocked and the next locked ID or --- (if there are no other locked IDs) appears.
4. Press **SRCH** to continue the scanner's previous function.

Unlocking All IDs

Hold down **L/O** until you hear two short beeps. Then press **E** to unlock all the IDs at once. -The scanner beeps twice.

Note: When you unlock all the IDs, the scan list mode appears. Press **SCAN** to scan the IDs stored in your scan lists or press **SRCH** to continue the scanner's previous function. For more information about scan lists, see "Scan Lists" on Page 41.

Using Trunk Tracking Scan Delay

Many trunked systems have a period of 2 or more seconds between a query and a reply. You can program a 5-second delay to hold on an ID for 5 seconds to wait for a reply. The scanner continues to monitor the frequency for 5 seconds after the transmission stops before resuming scanning.

Press **DLY** to turn trunk tracking scan delay on or off. **DLY** appears when trunk tracking scan delay is set.

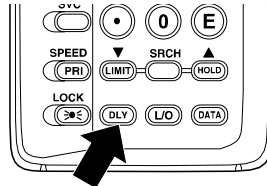

Note: If you consistently miss responses even with trunk tracking scan delay set, you might need to change the default system type or the fleet map you are using. See “Scanning Type I and Hybrid Trunked Systems” on Page 44.

Monitoring IDs

You can use your scanner’s display to monitor the frequencies in a trunked system for activity. You cannot hear conversations in this mode, but this is an excellent way to determine which talk groups are the most active. To set the scanner to monitor IDs, hold down **SRCH** until the scanner beeps twice. **SRCH** flashes, and all active talk group IDs appear in succession. To stop monitoring IDs, press **SRCH** again.

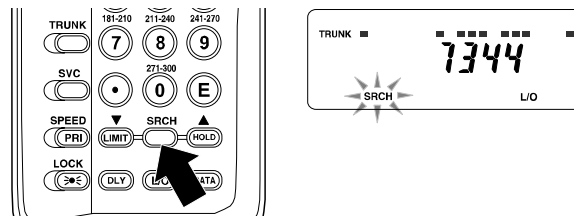

Note: When you monitor IDs, locked-out IDs also appear.



CHANNEL ACTIVITY INDICATORS

Your scanner has 20 channel activity indicators (bars) which show the activity taking place on a trunked system. You can see how many frequencies are being used and generally monitor how much communication traffic is occurring.

Each frequency you store in a trunking bank has a corresponding activity indicator. However, since there are only 20 indicators, but you can store up to 30 frequencies, some indicators might indicate more than one frequency if the trunked system you are scanning has more than 20 channels.

- The indicator that remains on steadily even when there are no current transmissions represents the frequency being used as the data channel.

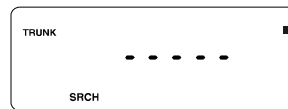

- The indicator that flashes when an ID appears represents the frequency being used by the radio you are currently hearing.



- If an indicator turns on but you do not hear a conversation, the channel is probably being used for a telephone interconnect call or a private call, or the indicator might be a locked-out ID. Your scanner does not monitor these types of calls.

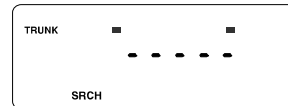

- If the scanner is holding on an ID which is not active, the other activity indicators turn on and off as other groups use the system.

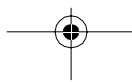
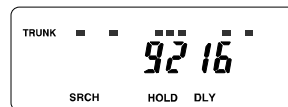

SCAN LISTS

When you program trunked frequencies into a bank (see "Programming Trunked Frequencies" on Page 34), your scanner sets up 5 scan lists into which you can store your favorite IDs. Each list can contain up to 10 IDs, so you can store a total of 50 IDs for each trunk tracking bank (500 IDs if you use all banks as trunking banks!). Scan lists help you organize trunking system users into categories. For example, you might use List 1 for police IDs, List 2 for fire department IDs, List 3 for emergency medical service IDs, and so on. Once IDs are stored in lists, you can scan them like you scan conventional channels. You can program IDs into scan lists manually, during a search, or automatically.

Manually Storing IDs into Scan Lists

1. Select the trunking bank you want (see "Scanning a Trunked Bank" on Page 36).
2. After the scanner begins trunk tracking, press **MANUAL**. A bar appears at the top of the display, showing the current scan list.

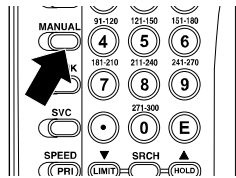

3. Repeatedly press **s** or **t** to select the scan list location (shown at the top of the display) you want to program.

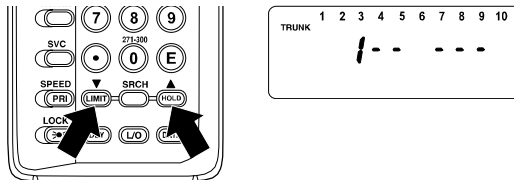

4. Enter the Type II ID you want to store, then press **E**.

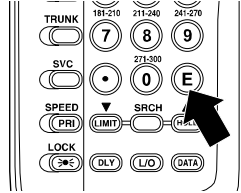

Or, to enter a Type I ID:

- Use the number keys to enter the block number and the fleet number, then press **●**.
- Enter the subfleet number, then press **E**.

Note: To clear a mistake while entering an ID, press **●** twice, then start over at Step 1.

5. Repeatedly press **MANUAL** or **s** to select the next scan list location you want to program. Then repeat Step 4 to enter another ID.

Storing IDs Into Scan Lists While Searching

Follow these steps to select a scan list location and store an ID during a search.

- When your scanner stops on an ID you want to store, press **PRI**. The currently selected scan list memory location flashes.
- Press **E** to store the ID in the selected scan list memory location. Or, repeatedly press **s** or **t** to select the scan list memory location you want, then press **E**.
- Press **SRCH** to resume searching.

Automatically Storing an ID in a Scan List Location

Follow these steps to store an ID in the first empty scan list location during a search.

- When your scanner stops on an ID you want to store, press **E**. The scanner stores the ID in the displayed scan list location.

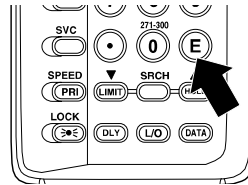

2. Press **SRCH** to resume searching.

Deleting a Stored ID

1. Repeatedly press **s** or **t** to select the scan list location (shown at the top of the display) you want to delete.

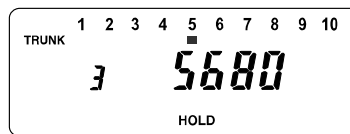

2. Press **0** then **E**.

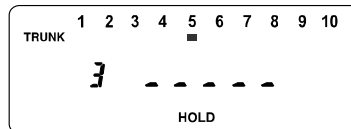

SCANNING THE SCAN LISTS

Press **SCAN** to begin scanning the lists you have programmed.

Note: If you haven't programmed any IDs, **SCAN** scrolls on the display but your scanner does not stop on an active conversation.

To remove a scan list from active scanning, use the number keys to enter the scan list's number. The scan



list indicator turns off, and the IDs in that list are not scanned.



Note: One scan list must always be active. If you try to remove all the scan lists, the first scan list will stay active.

To restore a scan list to active scanning, use the number keys to enter its number again.

Press **SRCH** to return to the scanner's previous function.

To alternate the display between the channel activity indicators and the scan list indicators, press **PRI**.

SCANNING TYPE I AND HYBRID TRUNKED SYSTEMS



Your PRO-90 is set to scan Type II user IDs by default. When you scan trunked frequencies, each Type II user ID you see appears as an even number without a dash (such as 2160). Your PRO-90 can also scan Type I trunked systems. Each Type I ID appears as a three- or four-digit number, followed by a hyphen, followed by a one- or two-digit number (such as 200-14). If you notice a mix of odd- and even-user IDs (such as 6477, 2160, 6481, 6144, and 1167), then you are probably monitoring either a Type I or hybrid (a combination of Type I and Type 2 user IDs) system (see "Types of Trunked Systems" on Page 32).

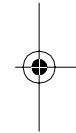

You might also notice that you are missing responses when you hold on an active ID. Unlike Type II systems, Type I and hybrid systems require a fleet map that sets specific fleet-subfleet parameters. It is easy to select a fleet map to scan; what is not always easy is selecting or programming a map that is being used in your particular area.

When a Type I system is designed, the address information for all its user IDs is divided into 8 equal-size blocks, numbered 0-7, and each block is assigned a size code.



44

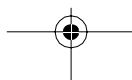

When you set up your scanner to track a Type I system, you must choose a size code for each block. When you have chosen a size code for all 8 blocks, you will have duplicated the *fleet map* for the system you are tracking. If you have chosen correctly, you will be able to track transmissions in that system.

Each size code defines the number of fleets, subfleets, and IDs each block has. For example, you can see in the following table that a size code of S-4 has one fleet, which is divided into 16 separate subfleets, and it has a total of 512 individual IDs.

Size	Fleets	Subfleets	IDs	Block Used
S-0	Reserved block for Type II IDs			
S-1	128	4	16	1
S-2	16	8	64	1
S-3	8	8	128	1
S-4	1	16	512	1
S-5	64	4	32	1
S-6	32	8	32	1
S-7	32	4	64	1
S-8	16	4	128	1
S-9	8	4	256	1
S-10	4	8	256	1
S-11	2	16	256	1
S-12	1	16	1024	2
S-13	1	16	2048	4
S-14	1	16	4096	8

Each ID in the block is unique. The left-most digit is the block number in the ID. The next two digits identify which fleet is active, and the last digit(s) (after the hyphen) identifies the subfleet.

The size codes selected by a Type I system designer depend on the specific needs of the system's users. Some organizations might want many subfleets with only a few radios each, while another organization might want only a few subfleets, with many radios each. To scan Type I

systems, you must select or program a fleet map with the same size code assignments as the trunked system. If you do this accurately, you will track all the fleet and subfleet combinations used by the system. In other words, you will hear complete communications while monitoring a trunked system.

Note: Preset fleet maps might be available at www.trunkscanner.com.

If you do not already know the size codes used, you will have to guess them. But since you do not have to figure out all the blocks at once, this is not as hard as it seems. Select a size code for a block, then press **SRCH**. Now listen to the communications. If you decide you are receiving most of the replies to the conversations with IDs assigned to the block you just programmed, then you have probably selected the right size code and can work on the next block of the map.

There are 16 preset fleet maps to choose from, and it is best to start with these when setting up a Type I or hybrid trunk tracking bank. If none of the following preset fleet maps allow you to follow complete conversations, then you probably need to program your own fleet map (see "Programming a Fleet Map" on Page 49).

E1P1		E1P2		E1P3	
Block	Size Code	Block	Size Code	Block	Size Code
0	S11	0	S4	0	S4
1	S11	1	S4	1	S4
2	S11	2	S4	2	S4
3	S11	3	S4	3	S4
4	S11	4	S4	4	S4
5	S11	5	S4	5	S4
6	S11	6	S4	6	S12
7	S11	7	S4	7	---

E1P4		E1P5		E1P6	
Block	Size Code	Block	Size Code	Block	Size Code
0	S12	0	S4	0	S3

1	---	1	S4	1	S10
2	S4	2	S12	2	S4
3	S4	3	---	3	S4
4	S4	4	S4	4	S12
E1P4		E1P5		E1P6	
Block	Size Code	Block	Size Code	Block	Size Code
5	S4	5	S4	5	---
6	S4	6	S4	6	S12
7	S4	7	S4	7	---

E1P7		E1P8		E1P9	
Block	Size Code	Block	Size Code	Block	Size Code
0	S10	0	S1	0	S4
1	S10	1	S1	1	S4
2	S11	2	S2	2	S0
3	S4	3	S2	3	S0
4	S4	4	S3	4	S0
5	S4	5	S3	5	S0
6	S4	6	S4	6	S0
7	S4	7	S4	7	S0

E1P10		E1P11		E1P12	
Block	Size Code	Block	Size Code	Block	Size Code
0	S0	0	S4	0	S0
1	S0	1	S0	1	S0
2	S0	2	S0	2	S0
3	S0	3	S0	3	S0
4	S0	4	S0	4	S0



5	S0	5	S0	5	S0
6	S4	6	S0	6	S0
7	S4	7	S0	7	S4

E1P13		E1P14		E1P15	
Block	Size Code	Block	Size Code	Block	Size Code
0	S3	0	S4	0	S4
1	S3	1	S3	1	S4
2	S11	2	S10	2	S4
3	S4	3	S4	3	S11
4	S4	4	S4	4	S11
5	S0	5	S4	5	S0
6	S0	6	S12	6	S12
7	S0	7	---	7	---

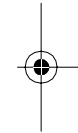

E1P16	
Block	Size Code
0	S3
1	S10
2	S10
3	S11
4	S0
5	S0
6	S12
7	---

Selecting a Preset Fleet Map

1. Select the bank where you want to store the preset fleet map by pressing a number key.



2. Press **DATA**.

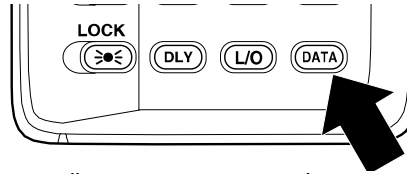

3. Repeatedly press **s** or **t** to select **E1**, then press **DATA** again.-

4. Repeatedly press **s** or **t** to select the name of the map you want (such as **P7**), then press **E**.

The scanner then searches for transmissions using the preset map you chose.

Note: When the scanner searches for transmissions, you see Type I fleet and subfleet IDs such as **100-12**, **100-9**, **000-12**, or **400-8**.

How do you know if the preset map you selected is correct? Listen to see if you are following complete conversations. If not, try another preset map.

Programming a Fleet Map

1. Select the bank where you want to program the fleet map by pressing a number key.

2. Press **DATA**.

3. Repeatedly press **s** or **t** until **E1** appears, then press **DATA**.-

4. Repeatedly press **s** or **t** until **USr** appears.

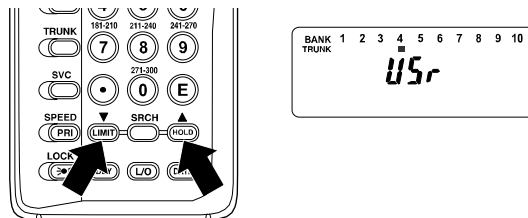

5. Press **DATA**.



6. Repeatedly press **s** or **t** to select the size code for the first block, then press **E**.- The next available

block appears.

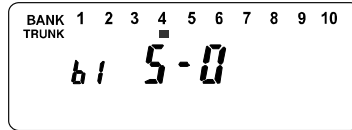

7. Repeat Step 6 until you have selected a size code for each block you want to work with.
8. Press **SRCH**. The scanner exits the trunking programming mode, tunes the data channel, then begins to search using the map you programmed.

Note: If you select size code S-12, S-13, or S-14, these restrictions apply:

- S-12 can only be assigned to Blocks 0, 2, 4, or 6.
- S-13 can only be assigned to Blocks 0 and 4.
- S-14 can only be assigned to Block 0.

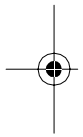

Since these size codes require multiple blocks, you will be prompted for the next available block when programming a fleet map. For example, if you assign Block 0 as an S-12, the scanner prompts you for **b2**, the next block available, instead of **b1**. And if you assign Block 0 as an S-14, you would not see another prompt because it uses all available blocks.

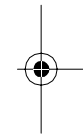

Programming a Hybrid System

A hybrid system is simply a Type I system with some of its blocks designated as Type II blocks. To program a hybrid system, follow the steps listed in "Programming a Fleet Map" on Page 49. However, if you want a block to be Type II, select size code **S-0** in Step 6.

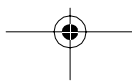



A GENERAL GUIDE TO SCANNING



Reception of the frequencies covered by your scanner is mainly "line-of-sight." That means you usually cannot hear stations that are beyond the horizon.

GUIDE TO FREQUENCIES

National Weather Frequencies

162.400	162.475	162.525
162.425	162.500	162.550
162.450		

Canadian Weather Frequencies

161.650	161.775	163.275
---------	---------	---------

Note: These frequencies are not pre-programmed in the weather service bank but can be manually programmed into a channel.

Birdie Frequencies

Every scanner has birdie frequencies. Birdies are signals created inside the scanner's receiver. These operating frequencies might interfere with broadcasts on the same frequencies. If you program one of these frequencies, you hear only noise on that frequency. If the interference is not severe, you might be able to turn **SQUELCH** clockwise to cut out the birdie. This scanner's birdie frequencies (in MHz) are:

41.6000	406.2000	438.4000	489.2500
118.8875	413.1750	445.8250	495.3625
138.7000	413.2250	445.8375	496.3750
138.7050	416.1125	455.7375	813.4000
158.5150	426.0125	465.6500	852.0375
158.5200	426.0250	475.5500	899.2375
168.4250	435.9250	485.4625	926.7000

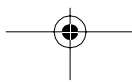
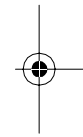
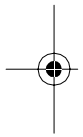



GUIDE TO THE ACTION BANDS

Typical Band Usage

VHF Band

Low Range	29.00–50.00 MHz
6-Meter Amateur	50.00–54.00 MHz
U.S. Government	137.00–144.00 MHz
2-Meter Amateur	144.00–148.00 MHz
High Range	148.00–174.00 MHz

UHF Band

U.S. Government	406.00–420.00 MHz
70-cm Amateur	420.00–450.00 MHz
Low Range	450.00–470.00 MHz
FM-TV Audio Broadcast, Wide Band	470.00–512.00 MHz
Public Service	806.00–823.93 MHz
Conventional Systems	851.00–856.00 MHz
Conventional/Trunked Systems	856.00–861.00 MHz
Trunked Systems	861.00–866.00 MHz
Public Safety	866.00–868.93 MHz
High Range	896.11–902.00 MHz
33-Centimeter Amateur	902.00–928.00 MHz
Private Trunked	935.00–940.00 MHz
General Trunked	940.00–941.00 MHz
Fixed Services	941.00–944.00 MHz
Studio-to-Transmitter Broadcast Links	944.00–952.00 MHz
Private Fixed Services, Paging	952.00–960.00 MHz
Aeronautical Navigation	960.00–1000.00 MHz

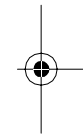
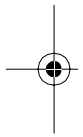

Primary Usage

As a general rule, most of the radio activity is concentrated on the following frequencies:

VHF Band

Activities	Frequencies
Government, Police, and Fire	153.785–155.980 MHz
Emergency Services	158.730–159.460 MHz
Railroad	160.000–161.900 MHz



UHF Band

Activities	Frequencies
Land-Mobile "Paired" Frequencies	450.000–470.000 MHz
Base Stations	451.025–454.950 MHz
Mobile Units	456.025–459.950 MHz
Repeater Units	460.025–464.975 MHz
Control Stations	465.025–469.975 MHz

Note: Remote control stations and mobile units operate at 5 MHz higher than their associated base stations and relay repeater units.

BAND ALLOCATION

To help decide which frequency ranges to scan, use the following listing of the typical services that use the frequencies your scanner receives. These frequencies are subject to change, and might vary from area to area. For a more complete listing, refer to the "Police Call Radio Guide including Fire and Emergency Services," available at your local RadioShack store.

Abbreviations Services

- BIFC Boise (ID) Interagency Fire Cache
- BUS Business
- CAP Civil Air Patrol
- CB Citizens Band
- CCA Common Carrier
- CSB Conventional Systems
- CTSB Conventional/Trunked Systems
- FIRE Fire Department
- HAM Amateur (Ham) Radio
- GOVT Federal Government
- GMR General Mobile Radio
- GTR General Trunked
- IND Industrial Services
(Manufacturing, Construction, Farming, Forest Products)
- MAR Military Amateur Radio
- MARI Maritime Limited Coast
(Coast Guard, Marine Telephone,
Shipboard Radio, Private Stations)
- MARS Military Affiliate Radio System
- MED Emergency/Medical Services
- MIL U.S. Military
- MOV Motion Picture/Video Industry
- NEW New Mobile Narrow
- NEWS Relay Press (Newspaper Reporters)
- OIL Oil/Petroleum Industry
- POL Police Department
- PUB Public Services
(Public Safety, Local Government, Forestry Conservation)
- PSB Public Safety

PTR Private Trunked
ROAD Road & Highway Maintenance
RTV Radio/TV Remote Broadcast Pickup
TAXI Taxi Services
TELB Mobile Telephone
 (Aircraft, Radio Common Carrier, Landline Companies)
TELC Cordless Phones
TELM Telephone Maintenance
TOW Tow Trucks
TRAN Transportation Services
 (Trucks, Tow Trucks, Buses, Railroad, Other)
TSB Trunked Systems
TVn FM-TV Audio Broadcast
USXX Government Classified
UTIL Power & Water Utilities
WTHR Weather

VERY HIGH FREQUENCY (VHF)

VHF Low Band—(29–50 MHz—in 5 kHz steps)

29.000–29.700 HAM
29.900–30.550 GOVT, MIL
30.580–31.980 IND, PUB
32.000–32.990 GOVT, MIL
33.020–33.980 BUS, IND, PUB
34.010–34.990 GOVT, MIL
35.020–35.980 BUS, PUB, IND, TELM
36.000–36.230 GOVT, MIL
36.250 Oil Spill Cleanup
36.270–36.990 GOVT, MIL
37.020–37.980 PUB, IND
38.000–39.000 GOVT, MIL
39.020–39.980 PUB
40.000–42.000 GOVT, MIL, MARI
42.020–42.940 POL
42.960–43.180 IND
43.220–43.680 TELM, IND, PUB
43.700–44.600 TRAN
44.620–46.580 POL, PUB
46.600–46.990 GOVT, TELC
47.020–47.400 PUB
47.420 American Red Cross
47.440–49.580 IND, PUB
49.610–49.990 MIL, TELC

6-Meter Amateur Band—(50–54 MHz)

50.00–54.00 HAM

Aircraft Band—(108–137 MHz)

108.00–121.490 AIR
121.500 AIR Emergency
121.510–136.000 AIR

U.S. Government Band (137–144 MHz)

137.000–144.000 GOVT, MIL

2-Meter Amateur Band (144–148 MHz)

144.000–148.000 HAM

VHF High Band (148–174 MHz)

148.050–150.345 CAP, MAR, MIL
150.775–150.790 MED
150.815–150.980 TOW, Oil Spill Cleanup

150.995-151.475	ROAD, POL
151.490-151.955	IND, BUS
151.985	TELM
152.0075	MED
152.030-152.240	TELB
152.270-152.480	IND, TAXI, BUS
152.510-152.840	TELB
152.870-153.020	IND, MOV
153.035-153.725	IND, OIL, UTIL
153.740-154.445	PUB, FIRE
154.490-154.570	IND, BUS
154.585	Oil Spill Cleanup
154.600-154.625	BUS
154.655-156.240	MED, ROAD, POL, PUB
156.255-157.425	OIL, MARI
157.450	MED
157.470-157.515	TOW
157.530-157.725	IND, TAXI
157.740	BUS
157.770-158.100	TELB
158.130-158.460	BUS, IND, OIL, TELM, UTIL
158.490-158.700	TELB
158.730-159.465	POL, PUB, ROAD
159.480	OIL
159.495-161.565	TRAN
161.580-162.000	OIL, MARI, RTV
162.0125-162.35	GOVT, MIL, USXX
162.400-162.550	WTHR
162.5625-162.6375	GOVT, MIL, USXX
162.6625	MED
162.6875-163.225	GOVT, MIL, USXX
163.250	MED
163.275-166.225	GOVT, MIL, USXX
166.250	GOVT, RTV, FIRE
166.275-169.400	GOVT, BIFC
169.445-169.505	Wireless Mikes, GOVT
169.55-169.9875	GOVT, MIL, USXX
170.000-170.150	BIFC, GOVT, RTV, FIRE
170.175-170.225	GOVT
170.245-170.305	Wireless Mikes
170.350-170.400	GOVT, MIL
170.425-170.450	BIFC
170.475	PUB
170.4875-173.175	GOVT, PUB, Wireless Mikes
173.225-173.5375	MOV, NEWS, UTIL, MIL
173.5625-173.5875	MIL Medical/Crash Crews
173.60-173.9875	GOVT

ULTRA HIGH FREQUENCY (UHF)

U. S. Government Band (406-420 MHz)

406.125-419.975	GOVT, USXX
-----------------	------------

70-cm Amateur Band (420-450 MHz)

420.000-450.000	HAM
-----------------	-----

Low Band (450-470 MHz)

450.050-450.925	RTV
451.025-452.025	IND, OIL, TELM, UTIL
452.0375-453.00	IND, TAXI, TRAN TOW, NEWS
453.0125-454.000	PUB, OIL
454.025-454.975	TELB
455.050-455.925	RTV
457.525-457.600	BUS



458.025–458.175	MED
460.0125–460.6375	FIRE, POL, PUB
460.650–462.175	BUS
462.1875–462.450	BUS, IND
462.4625–462.525	IND, OIL, TELM, UTIL
462.550–462.925	GMR, BUS
462.9375–463.1875	MED
463.200–467.925	BUS

**FM-TV Audio Broadcast, UHF Wide Band (470–512 MHz)
(Channels 14 through 69 in 6 MHz steps)**

475.750	Channel 14
481.750	Channel 15
487.750	Channel 16
.
.
511.750	Channel 20

Note: Some cities use the 470–512 MHz band for land/
mobile service.

Conventional Systems Band – Locally Assigned

851.0125–855.9875	CSB
-------------------	-----------	-----

Conventional/Trunked Systems Band – Locally Assigned

856.0125–860.9875	CTSB
-------------------	-----------	------

Trunked Systems Band – Locally Assigned

861.0125–865.9875	TSB
-------------------	-----------	-----

Public Safety Band – Locally Assigned

866.0125–868.9875	PSB
-------------------	-----------	-----

33-Centimeter Amateur Band (902–928 MHz)

902.0000–928.0000	HAM
-------------------	-----------	-----

Private Trunked

935.0125–939.9875	PTR
-------------------	-----------	-----

General Trunked

940.0125–940.9875	GTR
-------------------	-----------	-----

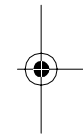
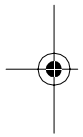



FREQUENCY CONVERSION

The tuning location of a station can be expressed in frequency (kHz or MHz) or in wavelength (meters). The following information can help you make the necessary conversions.

1 MHz (million) = 1,000 kHz (thousand)

To convert MHz to kHz, multiply the number of megahertz by 1,000:

$$9.62 \text{ (MHz)} \times 1000 = 9620 \text{ kHz}$$

To convert from kHz to MHz, divide the number of kilohertz by 1,000:

$$2780 \text{ (kHz)} \div 1000 = 2.780 \text{ MHz}$$

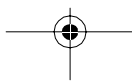
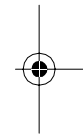
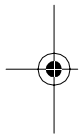

To convert MHz to meters, divide 300 by the number of megahertz:

$$300 \div 7.1 \text{ MHz} = 42.25 \text{ meters}$$



TROUBLESHOOTING

If you have problems, here are some suggestions that might help. If they do not, take your scanner to your local RadioShack store for assistance.

PROBLEM	POSSIBLE CAUSE	REMEDY
Scanner is on but will not scan.	SQUELCH is not correctly adjusted.	Adjust SQUELCH counterclockwise.
	Only one channel or no channels are stored.	Store frequencies into more than one channel.
Scanner is totally inoperative.	No power.	Check the battery pack or make sure the scanner is plugged into a working AC or DC outlet.
		Recharge the battery pack.
	The AC adapter/charger or DC adapter is not connected.	Be sure the adapter's barrel plug is fully plugged into the EXT. PWR jack.
The scanner's display dims or the scanner sounds a tone every 15–30 seconds.	The battery pack is not correctly installed.	Make sure the battery pack is installed properly.
	The battery pack is weak.	Recharge the battery pack.
Keypad does not work.	The keylock function is activated.	To turn off the keylock, press LOCK/  until  disappears from the display.
 appears.	The battery pack is weak.	Recharge the battery pack.
Poor or no reception.	Battery pack is weak or completely discharged.	Check the battery pack, make sure the scanner is plugged into a working AC or DC outlet.

PROBLEM	POSSIBLE CAUSE	REMEDY
Poor or no reception (continued)	An antenna is not connected or connected incorrectly.	Make sure an antenna is connected to the scanner.
Error appears.	Programming error.	Reprogram the frequency correctly, including the decimal point.
In the scan mode, the scanner locks on frequencies that have an unclear transmission.	Programmed frequencies are the same as "birdie" frequencies.	Avoid programming frequencies listed under "Birdie Frequencies" on Page 51 or only listen to them manually.
Scanner will not track a trunked system.	The transmission might not use a system that can be tracked by your scanner.	Scan another transmission.
	The data frequency is missing.	Find the data frequency (see "Programming Trunked Frequencies" on Page 34).
	The system you are trying to track is a Type I system, and the scanner is set to scan Type II systems.	Set the scanner to receive Type I trunked frequencies. See "Scanning Type I and Hybrid Trunked Systems" on Page 44.
Scanner will not stop while scanning a scan list.	No IDs have been stored.	Store one or more IDs (see "Scan Lists" on Page 41).
	The IDs you have stored are not active.	Scan another transmission.

PROBLEM	POSSIBLE CAUSE	REMEDY
Scanner will not acquire a data channel.	SQUELCH is not correctly adjusted for trunk tracking.	Adjust squelch for trunk tracking. See "Setting Squelch for the Trunk Tracking Mode" on Page 33.
	The frequency used for the data channel is missing.	Add the frequency used for the data channel to the frequency list. (see "Programming Trunked Frequencies" on Page 34).
Missing replies to conversations.	The system you are trying to track is a Type I system, and the scanner is set to scan Type II systems.	Set the scanner to receive Type I trunked frequencies. See "Scanning Type I and Hybrid Trunked Systems" on Page 44.
	The selected fleet map is incorrect.	Try another preset fleet map or program your own fleet map (see "Scanning Type I and Hybrid Trunked Systems" on Page 44).
	Not all of the trunk's frequencies have been entered.	Enter all of the trunk's frequencies.
Channel activity indicators are flashing but no sound is heard.	The transmission might be a private or telephone interconnect call. The scanner does not scan these types of transmissions.	Scan for another transmission.
	The ID shown is not active.	Wait for the ID to become active, or scan another transmission.



CARE AND MAINTENANCE



Your RadioShack PRO-90 300-Channel TrunkTracker Scanner is an example of superior design and craftsmanship. The following suggestions will help you care for your scanner so you can enjoy it for years.



Keep the scanner dry. If it gets wet, wipe it dry immediately. Liquids can contain minerals that can corrode the electronic circuits.



Use only rechargeable batteries of the recommended size and type. Always remove old and weak batteries. They can leak chemicals that destroy electronic circuits.



Handle the scanner gently and carefully. Dropping it can damage circuit boards and cases and can cause the scanner to work improperly.



Use and store the scanner only in normal temperature environments. Temperature extremes can shorten the life of electronic devices, damage batteries, and distort or melt plastic parts.



Keep the scanner away from dust and dirt, which can cause premature wear of parts.



Wipe the scanner with a damp cloth occasionally to keep it looking new. Do not use harsh chemicals, cleaning solvents, or strong detergents to clean the scanner.

Modifying or tampering with the scanner's internal components can cause a malfunction, invalidate your scanner's warranty and void your FCC authorization to operate it. If your scanner is not operating as it should, take it to your local RadioShack store for assistance.



SPECIFICATIONS

Frequency Coverage: 29–54 MHz (in 5 kHz steps)
108–136.9875 MHz (in 12.5 kHz steps)
137–174 MHz (in 5 kHz steps)
406–512 MHz (in 12.5 kHz steps)
806.0000–823.9875 MHz (in 12.5 kHz steps)
849.0125–868.9875 MHz (in 12.5 kHz steps)
894.0125–956.0000 MHz (in 12.5 kHz steps)

Channels 300

Number of Banks 10

Sensitivity (AM/FM):

NFM: 20 dB S/N at 3 kHz deviation):

29–54 MHz 0.5 μ V
137–174 MHz 0.4 μ V
406–512 MHz 0.4 μ V
806–956 MHz 0.6 μ V

AM: 20 dB S/N at 60% modulation):

108–136.9875 MHz 1.5 μ V

Spurious Rejection (at 40.84 MHz) 50 dB

Selectivity:

10 kHz –6 dB
15 kHz –50 dB

IF Rejection (at 162.4 MHz) 80 dB

Operating Temperature .. –4° to 140° F (–20° to 60° C)

Scan Speed:

Normal 100 Channels/Second
Service 100 Frequencies/Second

Search Speed:

Normal 100 Steps/Second
Hypersearch 300 Steps/Second

Priority Sampling 2 Seconds

Delay Time 2 Seconds

IF Frequencies ... 380.7 MHz, 10.85 MHz, and 450 kHz

Antenna Impedance 50 Ohms

Audio Output 180 mW nominal into 8 Ohm
Internal speaker

38 mW nominal into 32 Ohm Stereo Headphones

9 mW nominal into 64 Ohm Earphone

Built-in Speaker Size 1 $\frac{1}{2}$ -inch (36 mm)



Power Requirements Rechargeable Battery Pack
(4.8 VDC), or
AC Adapter/Charger or
Optional DC Adapter (12 VDC 200 mA)

Current Drain:

Squelched 70 mA
Full Output 180 mA

Dimensions (HWD) $6 \times 2\frac{1}{3} \times 1\frac{11}{16}$ Inches
(153 × 63.5 × 43 mm)

Weight 11 oz
(310 g)

Specifications are typical; individual units might vary.
Specifications are subject to change and improvement
without notice.

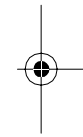
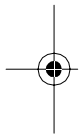



Limited One-Year Warranty

This product is warranted by RadioShack against manufacturing defects in material and workmanship under normal use for one (1) year from the date of purchase from RadioShack company-owned stores and authorized RadioShack franchisees and dealers. EXCEPT AS PROVIDED HEREIN, RadioShack MAKES NO EXPRESS WARRANTIES AND ANY IMPLIED WARRANTIES, INCLUDING THOSE OF MERCHANTABILITY AND FITNESS FOR A PARTICULAR PURPOSE, ARE LIMITED IN DURATION TO THE DURATION OF THE WRITTEN LIMITED WARRANTIES CONTAINED HEREIN. EXCEPT AS PROVIDED HEREIN, RadioShack SHALL HAVE NO LIABILITY OR RESPONSIBILITY TO CUSTOMER OR ANY OTHER PERSON OR ENTITY WITH RESPECT TO ANY LIABILITY, LOSS OR DAMAGE CAUSED DIRECTLY OR INDIRECTLY BY USE OR PERFORMANCE OF THE PRODUCT OR ARISING OUT OF ANY BREACH OF THIS WARRANTY, INCLUDING, BUT NOT LIMITED TO, ANY DAMAGES RESULTING FROM INCONVENIENCE, LOSS OF TIME, DATA, PROPERTY, REVENUE, OR PROFIT OR ANY INDIRECT, SPECIAL, INCIDENTAL, OR CONSEQUENTIAL DAMAGES, EVEN IF RadioShack HAS BEEN ADVISED OF THE POSSIBILITY OF SUCH DAMAGES.

Some states do not allow the limitations on how long an implied warranty lasts or the exclusion of incidental or consequential damages, so the above limitations or exclusions may not apply to you.

In the event of a product defect during the warranty period, take the product and the RadioShack sales receipt as proof of purchase date to any RadioShack store. RadioShack will, at its option, unless otherwise provided by law: (a) correct the defect by product repair without charge for parts and labor; (b) replace the product with one of the same or similar design; or (c) refund the purchase price. All replaced parts and products, and products on which a refund is made, become the property of RadioShack. New or reconditioned parts and products may be used in the performance of warranty service. Repaired or replaced parts and products are warranted for the remainder of the original warranty period. You will be charged for repair or replacement of the product made after the expiration of the warranty period.

This warranty does not cover: (a) damage or failure caused by or attributable to acts of God, abuse, accident, misuse, improper or abnormal usage, failure to follow instructions, improper installation or maintenance, alteration, lightning or other incidence of excess voltage or current; (b) any repairs other than those provided by a RadioShack Authorized Service Facility; (c) consumables such as fuses or batteries; (d) cosmetic damage; (e) transportation, shipping or insurance costs; or (f) costs of product removal, installation, set-up service adjustment or reinstallation.

This warranty gives you specific legal rights, and you may also have other rights which vary from state to state.

RadioShack Customer Relations, Dept. W,
100 Throckmorton St., Suite 600, Fort Worth, TX 76102

We Service What We Sell

3/97

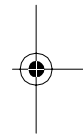
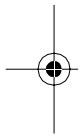

RadioShack
A Division of Tandy Corporation
Fort Worth, Texas 76102

8A7

UBZZ01271ZZ
Printed in the Philippines

